

## DS-2TD1228-3/QA Thermal & Optical Bi-spectrum Network Turret Camera

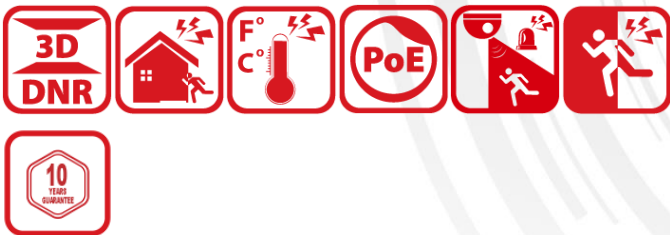

Hikvision DS-2TD1228-3/QA Thermal & Optical Bi-spectrum Network Turret Camera can be applied to villas, communities, parking lots, warehouses, construction sites, waste incineration plants, manufacturing workshops, etc. The accurate temperature measurement device sends temperature exception alarms for loss prevention.

- 256 × 192 resolution, 12 μm, VOx UFPA, NETD < 40 mK (25°C, F1.0)
- Video content analysis: vehicle/human classification
- Temperature exception alarm for fire prevention, -20°C to 150°C (-4°F to 302°F), ± 8°C (± 14.4°F)
- Image processing technology: linear, histogram, self-adaptive thermal AGC mode, DDE, 3D DNR
- High quality detector with 10 years guarantee

## ▪ Detection Range Table

VCA Range (Vehicles: 1.4 × 4.0 m)	VCA Range (Humans: 1.8 × 0.5 m)	Temperature Measurement (Object: 0.2 × 0.2 m)	Temperature Measurement (Object: 1 × 1 m)
75.6 m	28.4m	11.7 m	58.3 m

## ▪ DORI

\* The table is only for reference and the performance may vary according to different environment.

\* The optimal human detection, recognition, and identification distances are calculated according to Johnson's Criteria.

Detection Range: In order to distinguish an object from the background, the object must be covered by 1.5 or more pixels.

Recognition Range: In order to classify the object (animal, human, vehicle, etc.), the object must be covered by 6 or more pixels.

Identification Range: In order to identify the object and describe it in details, the object must be covered by 12 or more pixels.

Detection Range (Vehicles: 1.4 × 4.0 m)	Detection Range (Humans: 1.8 × 0.5 m)	Recognition Range (Vehicles: 1.4 × 4.0 m)	Recognition Range (Humans: 1.8 × 0.5 m)	Identification Range (Vehicles: 1.4 × 4.0 m)	Identification Range (Humans: 1.8 × 0.5 m)
460 m	150 m	112 m	38 m	56 m	19 m

## ▪ Specification

Thermal Module	
Image Sensor	Vanadium Oxide Uncooled Focal Plane Arrays
Resolution	256 × 192
Pixel Pitch	12 μm
Spectral Range	8 μm to 14 μm
NETD	< 40 mK (25°C, F1.1)
Focal Length	3.6 mm
IFOV	3.33 mrad
Field of View	50.0°(H) x37.3°(V)
Min. Focusing Distance	0.4 m
Aperture	F1.0
Digital Zoom	×2, ×4
Optical Module	
Image Sensor	1/2.7" Progressive Scan CMOS
Resolution	2688 × 1520
Min. Illumination	0.0089Lux @(F1.6,AGC ON) ,0 Lux with IR
Shutter Speed	1 s to 1/100,000 s
Focal Length	4.3 mm
Field of View	84.0°(H) x43.1°(V)
Aperture (Range)	F1.6
WDR	120 dB

<b>Image Effect</b>	
Target Coloration	Yes. Supported in white hot and black hot mode.
<b>Illuminator</b>	
IR Distance	Up to 15 m
IR Intensity and Angle	Automatically adjusted
<b>Audible and Visual Alarm</b>	
White Light Range	Up to 30 m
Visual Alarm	Yes. White light alarm with adjustable flashing frequencies
Audio alarm	Yes, for two types of audible alarm (VCA and Temperature Exception) 2 preset voice alerts (one for each) 6 importable user-defined voice alerts (6 options shared in the two types)
<b>Smart Function</b>	
VCA	4 VCA rule types (line crossing, intrusion, region entrance, and region exiting), up to 8 VCA rules in total.
Temperature Measurement	3 temperature measurement rule types, 21 rules in total (10 points, 10 areas, and 1 line)
Temperature Range	-20°C to 150°C (-4°F to 302°F)
Temperature Accuracy	±8°C (±14.4°F)
<b>Video and Audio</b>	
Main Stream	Thermal: 25 fps (1280 × 720, 704 × 576, 640 × 512, 320 × 240) Optical: 50 Hz: 25 fps (2688 × 1520, 1920 × 1080, 1280 × 720) 60Hz: 30 fps (2688 × 1520, 1920 × 1080, 1280 × 720)
Sub-stream	Thermal: 25 fps (704 × 576, 640 × 512, 320 × 240) Optical: 50 Hz: 25 fps (704 × 576, 352 × 288) 60 Hz: 30 fps (704 × 480, 352 × 240)
Video Compression	Main Stream: H.265/H.264 Sub-Stream: H.265/H.264/MJPEG
Audio Compression	G.722.1/G.711ulaw/G.711alaw/MP2L2/G.726/PCM
<b>Network</b>	
Protocols	IPv4/IPv6, HTTP, HTTPS, 802.1x, QoS, FTP, SMTP, UPnP, SNMP, DNS, DDNS, NTP, RTSP, RTCP, RTP, TCP, UDP, IGMP, ICMP, DHCP, PPPoE, Bonjour, SFTP, SRTP
Network Storage	MicroSD/SDHC/SDXC card (up to 256 G) local storage, NAS (NFS, SMB/CIFS), Auto Network Replenishment (ANR)
API	ISAPI, HIKVISION SDK, and third-party management platform, Open Network Video Interface (Profile S, Profile G)
Simultaneous Live View	Up to 20 channels
User/Host level	Up to 32 users, 3 levels: Administrator, Operator, User

Security	User authentication (ID and password), MAC address binding, HTTPS encryption, IEEE 802.1x(EAP-MD5, EAP-TLS), access control, IP address filtering
Client	iVMS-4200, Hik-Connect
Web Browser	Live view (plug-in allowed) : Internet Explorer 11 Live view (plug-in free) : Chrome 57.0 +, Firefox 52.0 + Local service : Chrome 57.0+, Firefox 52.0 +
<b>Interface</b>	
Alarm Input	1, alarm input (0-5 VDC)
Alarm Output	1, alarm output (alarm response actions configurable)
Alarm Action	SD recording/Relay output/Smart capture/FTP upload/Email linkage
Audio Input	1, 3.5 mm Mic in/Line in interface Line input: 2 - 2.4 V [p-p], output impedance: 1 K $\Omega$ $\pm$ 10%
Audio Output	Linear level, impedance: 600 $\Omega$
Communication Interface	1, RJ45 10 M/100 M Self-adaptive Ethernet interface. 1, RS-485 interface (half duplex)
<b>General</b>	
Web Client Language	32 languages English, Russian, Estonian, Bulgarian, Hungarian, Greek, German, Italian, Czech, Slovak, French, Polish, Dutch, Portuguese, Spanish, Romanian, Danish, Swedish, Norwegian, Finnish, Croatian, Slovenian, Serbian, Turkish, Korean, Traditional Chinese, Thai, Vietnamese, Japanese, Latvian, Lithuanian, Portuguese (Brazil)
Power Supply	12 VDC $\pm$ 25%, $\phi$ 5.5 mm coaxial power plug PoE (802.3af, class 3)
Power Consumption	12 VDC $\pm$ 25%: 0.5 A, Max 6 W PoE (802.3af, class 3): 42.5 V to 57 V, 0.14 A to 0.22 A, Max 6.5 W
Working Temperature/Humidity	Temperature: -40°C to 65°C (-40°F to 149°F) Humidity: 95% or less
Protection Level	IP66 Standard TVS 6000V lightning protection, surge protection, voltage transient protection
Dimensions	138.3 mm $\times$ 138.3 mm $\times$ 123.1 mm (5.45" $\times$ 5.45" $\times$ 4.85")
Weight	940 g (2.07 lb)

### ▪ Available Model





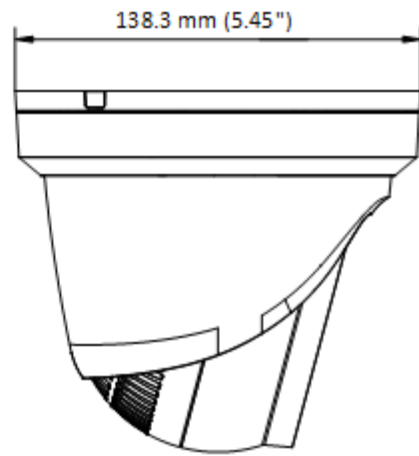
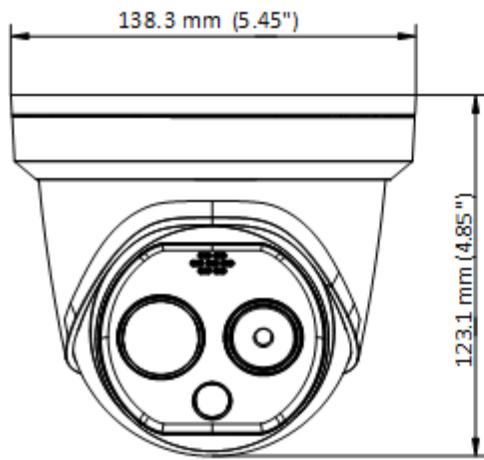

DS-2TD1228-3/QA(海外标配),DS-2TD1228-3/QA(海外中性),





### ▪ Dimension

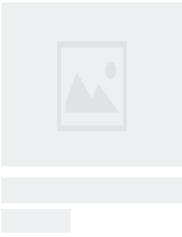
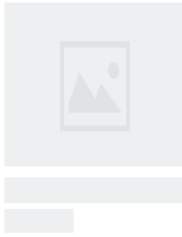

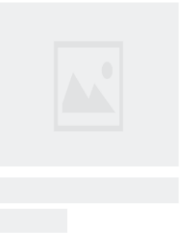
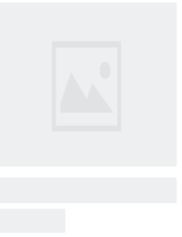
▪ **Accessory**

▪ **Optional**

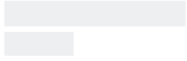
DS-1271ZJ-140 Pendant Mount	DS-1275ZJ-SUS Vertical Pole Mount	DS-1273ZJ-140B Wall Mount	DS-1276ZJ-SUS Corner Mount	DS-1273ZJ-140 Wall Mount
				
				

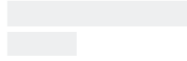
<b>DS-1280ZJ-DM21</b> <b>Junction box</b>	<b>DS-1273ZJ-140(B</b> <b>LACK)</b>
	
 	 

**Headquarters**

No.555 Qianmo Road, Binjiang District,  
Hangzhou 310051, China  
T +86-571-8807-5998  
www.hikvision.com



Follow us on social media to get the latest product and solution information.

